

A1

FLEXFLO® Peristaltic Metering Pump



Features

- > Tube Failure Detection (TFD+) senses tube rupture
- > Heavy duty display shield protects pump controls
- > Brushless DC variable speed motor for precise flows
- > “C” Control Model includes multiple Input/Output options
- > “B” Base Model includes manual speed control
- > FDA compliant tubing

Video link: 



Highlights

Flow range

0.003 – 5.60 GPH
0.011 – 21.2 LPH

Pressures

100 PSI
(6.89 bar)

Turndown ratio

2,000 : 1

Exclusive

Tube Failure Detection
(TFD+) System

Motor

Brushless
DC

Warranty

2 Years

Control Methods

Control Methods	Manual Control	4-20mA Input	Remote Start/Stop	4-20mA Output	Alarm Output	FVS	Motor Status Output	Prime Button	Lockout Feature
A1C	•	•	•	•	•	•	•	•	•
A1B	•							•	•



Engineering Specifications

A1

Maximum Working Pressure	100 psig (6.89 bar)
Maximum Fluid Temperature	185 °F (85 °C)
Maximum Ambient Temperature	14 °F to 115 °F/ -10 °C to 46 °C
Maximum Viscosity	5,000 Centipoise
Maximum Suction Lift	30 ft. Water at sea level (14.7 atm psi)
Operating Voltage	115V60Hz 1 PH (0.6A max., 80 W max.)
	220V50Hz 1 PH (0.3A max., 80 W max.)
	230V60Hz 1 PH (0.3A max., 80 W max.)
	230V50Hz 1 PH (0.3A max., 80 W max.)
	240V50Hz 1 PH (0.3A max., 80 W max.)
Power Cord Options	115V60Hz = NEMA 5/15 (USA)
	230V60Hz = NEMA 6/15 (USA)
	220V50Hz = CEE 7/VII (EU)
	240V50Hz = AS 3112 (Australia/New Zealand)
	230V50Hz = BS 1363/A (UK)
Signal Connectors	M12 - 5 pin (IP67 rated connectors on "C" models)
Motor	Brushless DC, 42W
Duty Cycle	Continuous
Motor Speed Adjustment Resolution	2,000 : 1 (0.05 - 100%) Max rpm = 65 rpm
Maximum Overall Dimensions	7.25" W x 9" H x 10" D (18.5 W x 22.9 H x 25.2 D cm)
Product Weight	6 lb. (2.7 Kg)
Approximate Shipping Weight	13 lb. (5.9 Kg)
Approximate Shipping Dimensions	10.5" W x 13.75" H x 11" D (26.7 W x 35 H x 28 D cm)
Enclosure	NEMA 4X, Valox® (PBT) & PA12
RoHS Compliant	Yes
Standards	cETLus, CE

Materials of Construction

A1

Non-wetted Components:		Wetted Components:	
Enclosure:	Valox® (PBT) & PA12	Pump Head Assembly:	Tubing**: Flex-A-Prene®, Flex-A-Thane®, Flex-A-Chem®
Pump Head:	Valox® (PBT)		Adapter Fittings: PVDF
Pump Head Cover:	Acrylic Permanently lubricated sealed motor shaft support bronze sleeve bearing.		Body & Insert: PVDF
Cover Screws:	Stainless steel, polypropylene cap	Injection / Back-Flow Check Valve:	Check Ball: Ceramic
Roller Assembly:	Rotor: Valox® (PBT) Rollers: Nylon Roller Bearings: Bronze		Spring: Hastelloy C-276
Motor Shaft:	Chrome plated steel		Ball Seat O-Ring: TFE/P
TFD System Sensor:	Polysulfone (PES)		Static Seal O-Ring: FKM
Power Cord:	3 Conductor, SJTW-A water-resistant	Ancillary Items Provided:	Suction Tubing: 3/8" OD x 1/4" ID x 10' Clear PVC
Mounting Brackets and Hardware:	316 Stainless steel screws, GF Nylon bracket		Discharge Tubing: 3/8" OD x 1/4" ID x 10' Polyethylene (LLDPE)
			Suction Strainer: Polypropylene
			Weight: Ceramic

** Flex-A-Prene®, Flex-A-Thane®, and Flex-A-Chem® tubing comply with FDA 21 CFR, 117.2600 criteria for food processing.

NOTE: Additional Accessories, Tanks, and M12 Cables sold separately.

Output Specifications

Tube Model	Feed Rate			Max Speed	Max Pressure	Max Temperature
	GPH	LPH	mL/Min	RPM	PSI(bar)	°F(°C)
A1-1*	0.001 - 1.09	0.002 - 4.13	.035 - 69	65	65 (4.50)	130 (54)
A1-3*	0.003 - 5.60	0.011 - 21.2	.176 - 353	65	50 (3.45)	130 (54)
A1-4*	0.001 - 0.44	0.001 - 1.68	.014 - 28	65	100 (6.89)	130 (54)
A1-6*	0.001 - 1.35	0.003 - 5.14	.043 - 85	65	100 (6.89)	185 (85)
A1-7*	0.004 - 4.17	0.0158 - 15.8	.132 - 263	65	50 (3.45)	185 (85)
A1-8*	0.003 - 3.09	0.0117 - 11.7	.098 - 195	65	50 (3.45)	130 (54)

Dimensions

Dim	Inch	cm	Dim	Inch	cm
A	9.46"	24.02	D	7.18"	18.23
B	9.92"	25.19	E	1.5"	3.81
C	7.18"	18.23			

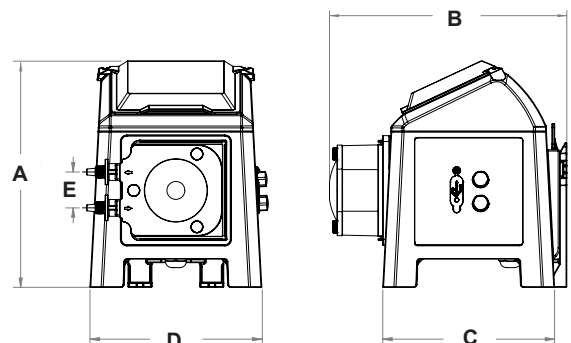







Model Number Matrix

A1

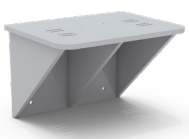
FLEXFLO® Model Number

A1	FLEXFLO® Peristaltic Metering Pump				
Series					
B	Base = Manual Speed Control (No I/O)				
C	Control = 4-20mA Input, 4-20mA Output, Manual Speed Control, Remote Start/Stop Input, Outputs (TFD, FVS, Motor)				
Power Cord (Operating voltage requirement 96VAC to 264VAC)					
4	115V 50/60Hz, NEMA 5/15 plug (US)	6	220V 50/60Hz, CEE 7/V11 plug (EU)	X	No Power Cord
Pump Tube Size and Material					
1	1/4" OD Flex-A-Thane® 0.001 – 1.09 GPH .035 - 69 mL/Min 65 PSI (4.5 bar)				
3	7/16" OD Flex-A-Thane® 0.003 – 5.60 GPH .176 - 353 mL/Min 50 PSI (3.45 bar)				
4	1/4" OD Flex-A-Prene® 0.001 - 0.44 GPH .014 - 28 mL/Min 100 PSI (6.89 bar)				
6	3/8" OD Flex-A-Prene® 0.001 – 1.35 GPH .043 - 85 mL/Min 100 PSI (6.89 bar)				
7	7/16" OD Flex-A-Prene® 0.002 – 4.17 GPH .132 - 263 mL/Min 50 PSI (3.45 bar)				
8	7/16" OD Flex-A-Chem® 0.002 – 3.09 GPH .098 - 195 mL/Min 50 PSI (3.45 bar)				
Inlet/Outlet Connection Size, Connection Type					
T	3/8" OD x 1/4" Tube Compression Fitting				
M	1/2" Male NPT Fitting				
MB	1/2" Male BSPT Fitting, Natural PVDF (Kynar)				
A1	B	4	-	1	T
Sample Model Number					

Accessories

 <p>KIT-S07 KIT-S15 KIT-S30</p> <p>* Includes cover and foot valve</p> <p>KIT-S07 (7 Gallon), KIT-S15 (15 Gallon), KIT-S30 (30 Gallon) STAR III TANKS, PP</p>	 <p>KIT-PSM (Lg), KIT-PSS (Sm) WALL MOUNT BRACKET, HDPE</p>	 <p>A-050 5mL A-100 10mL A-150 15mL</p> <p>A-050, A-100, A-150 SILICON OIL</p>	
<p>90010-663 115V/60Hz NEMA 5/15 90010-664 220V/50Hz CEE 7/V11 90010-665 230V/50Hz BS 1363/A 90010-666 240V/50Hz AS 3112 90010-696 230V/60Hz NEMA 6/15 90010-821 115V Lockable</p> <p>POWER CABLES - 6 ft</p>	 <p>CABLE-UAC USB A-C CABLE - 3 ft</p>	 <p>KIT-M12 TWO M12 CABLES - 9.8 ft</p>	 <p>A1-(see spare parts page) Spare Tube Element</p>
 <p>T140-6V T.I. INJECTOR, 3/8" OD</p>	 <p>C-340A FOOT VALVE</p>	<p>Visit Accessory Pages for More Options</p>	